

RFCT-SMA080-F37: SMA RIGHT ANGLE BULKHEAD JACK WITH O-RING RATED TO IP67/68, FOR 1.37MM CABLE, 6GHz

Material and plating:

1. Nut: Brass, gold plated.
2. Washer: Brass, gold plated.
3. Body A: Brass, gold plated.
Body B: Brass, gold plated.
Gasket: Silicone, color: red.
Center Contact: Phosphor Bronze, gold plated.
Insulator A: Teflon.
O-ring: Silicone, color: red.
4. Sleeve: Brass, nickel plated.
5. Insulator B: Teflon.
6. Cap: Brass, gold plated.

Environmental:

- A. Rated to:
- i. IP6x - Dust tight - no particle ingress.
 - ii. IPx7 Waterproof for 30 minutes up to 1 meter underwater.
 - iii. IPx8 Waterproof for 48 hours at 1 meter underwater.

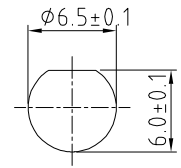
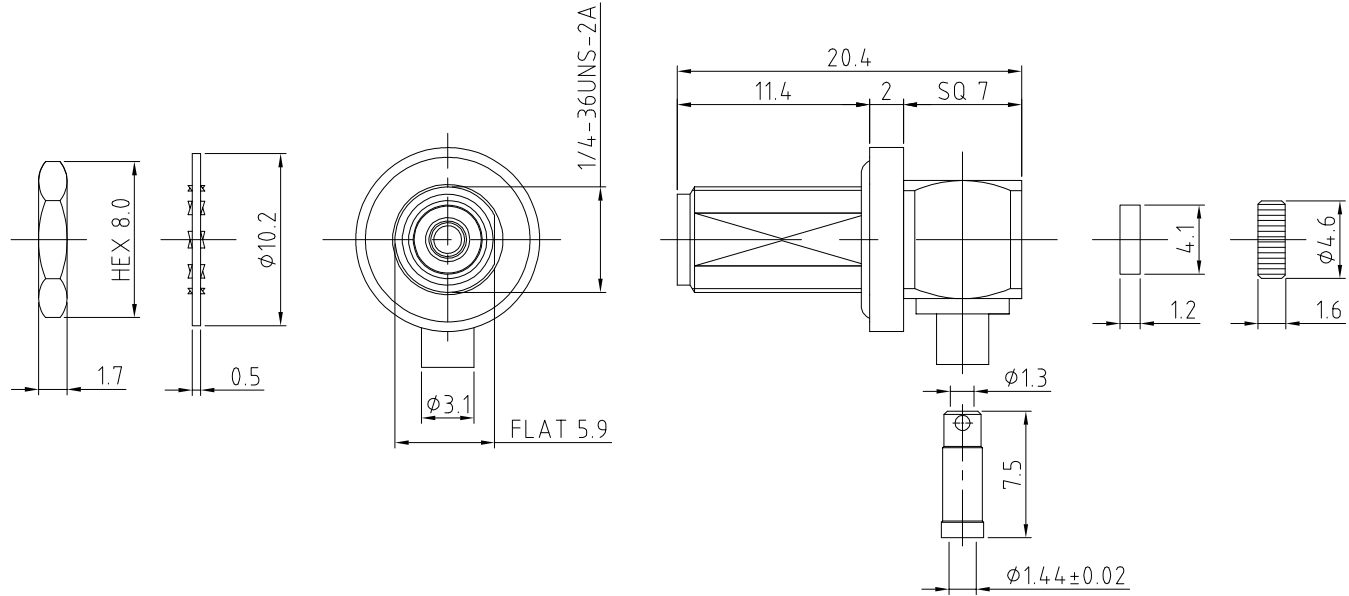

RECOMMENDED SMA MOUNTING HOLE
MAX. PANEL THICKNESS: 2.2MM

REV. DATE & DRN
10 19/03/20 - NYW RELEASE
11 03/08/21 - NYW
ADD WORKING FREQUENCY.

Scale: NTS	THIRD ANGLE	Unstated X .XX .XXX ANGLES	Tolerances: N/A N/A N/A N/A
Drawn: NYW			
App'd: XXX	Title SMA BULKHEAD JACK		
Date: 3 AUG. '21	Revision: 1.1	Unit: mm	

IP67/68 Rated Cables

www.gradconn.com

Type: RFCT-SMA080-F37
RFCT-SMA080-F37
Drawing Number:
Sheet 1 of 1
Drawing © E and O E