

CAB466RF: I-PEX MHF 4L LK PLUG + RP FRONT MOUNT SMA S/T BULKHEAD JACK WITH O-RING RATED TO IP67/68 + Ø1.37MM CABLE, 6GHz

SPECIFICATIONS :

1. I-PEX MHF 4L LK PLUG, P/N: 20632-001R-37. LOCK: 3615-000.
2. Ø1.37MM COAXIAL CABLE, COLOR: BLACK.
3. RP FRONT MOUNT SMA STRAIGHT BULKHEAD JACK WITH O-RING RATED TO IP67/68, P/N: RFCT-SMA088-F78.

ENVIRONMENTAL:

- A. BULKHEAD MOUNTED CONNECTOR (RFCT-SMA088-F78) RATED TO THE FOLLOWING SPECIFICATION:
- i. IP6X - DUST TIGHT - NO PARTICLE INGRESS.
 - ii. IPX7 WATERPROOF FOR 30 MINUTES UP TO 1 METER UNDERWATER.
 - iii. IPX8 WATERPROOF FOR 48 HOURS AT 1 METER UNDERWATER.

NOTES:

1. THE ORIENTATION OF CONNECTORS ON DRAWING IS FOR REFERENCE ONLY, IF THE ORDER IS LEFT BLANK THE CONNECTOR WILL NOT HAVE FIXED ORIENTATION.
2. FIXED ORIENTATION IS SUGGESTED FOR CABLE LENGTH 25MM TO 100MM. PLEASE SPECIFY THE FIXED ORIENTATIONS FROM THE ORDER CODE (F1, F2, ETC)
3. CONTACT GCT IF THE ORIENTATION YOU REQUIRE IS NOT SHOWN.
4. WORKING FREQUENCY RANGE: DC-6GHz.
5. OPERATING TEMPERATURE: -40°C~+85°C.
6. IMPEDANCE: 50 OHM.
7. IT IS INTENDED THAT MOUNTING OF THIS CONNECTOR IS ACHIEVED USING THE NUT AND WASHER PROVIDED. PLEASE CONTACT GCT FOR ADVISE IF PLANNING TO USE A DIFFERENT METHOD OF MOUNTING.

USAGE PRECAUTIONS: CABLES USING 'MICRO' COAX ARE DELICATE:

- (i) HANDLE WITH CARE.
- (ii) DO NOT TWIST; APPLY EXCESSIVE FORCES OR SHARP BENDS TO THE CABLE. DO NOT FORCEFULLY DEFORM WIRES.
- (iii) CONSULT CONNECTOR MANUFACTURER'S DATASHEETS FOR DETAILED NOTES ON HANDLING INSTRUCTIONS.

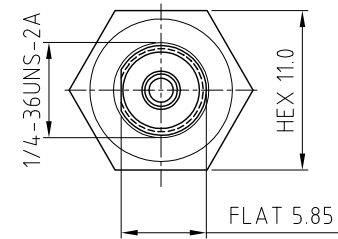
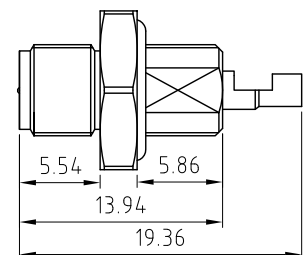
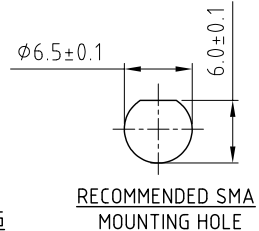
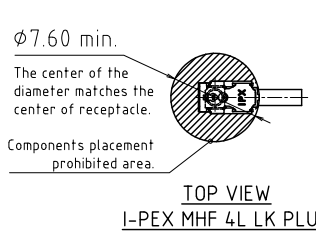
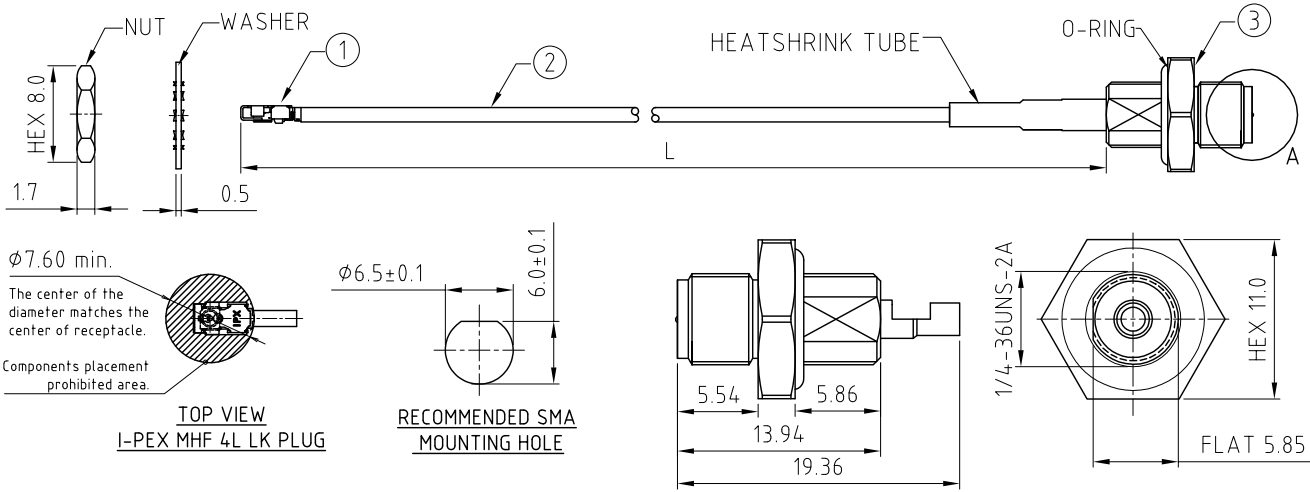
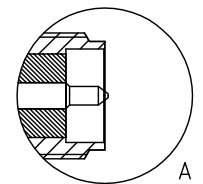

HOW TO ORDER
 CAB466RF - X X X X - X X - X - 1

"L" LENGTH IN MM:
 eg: 100MM = 0100
 (MIN. 0050-MAX.0400)
 STANDARD = 0100, 0150, 0200
 Tolerance: 50-200mm: ±5mm.
 201-400mm: ±7mm.

CABLE SIZE OPTION:
 1 = Ø1.37MM CABLE, COLOR: BLACK

WASHER AND NUT OPTIONS:
 BLANK = SEPARATELY PACKED (STANDARD)
 A = ALL ASSEMBLED WITH CONNECTOR

ORIENTATION OPTIONS:
 BLANK = DOES NOT HAVE A FIXED ORIENTATION
 F1 = MHF CONNECTION DOWN (L=50-200MM)
 F2 = MHF CONNECTION UP (L=50-200MM)
 F3 = MHF CONNECTION AND D FLAT SAME ORIENTATION (L=50-200MM)
 F4 = MHF CONNECTION AND D FLAT OPPOSITE ORIENTATION (L=50-200MM)
 (SEE NOTES 1, 2, 3 AND DIAGRAMS FOR MORE INFORMATION)

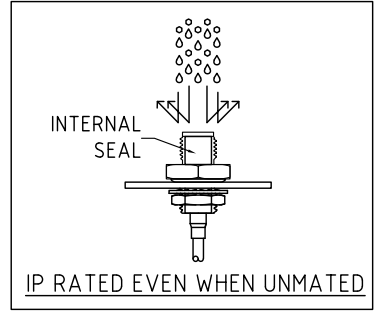
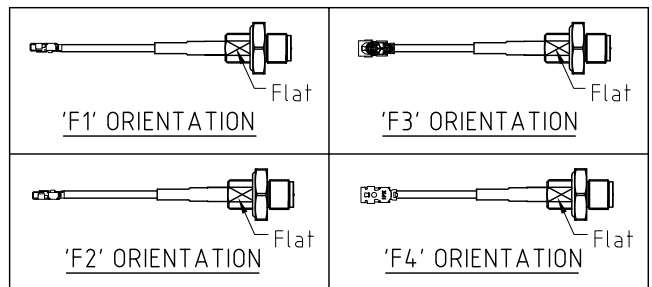

REV. DATE & DRN
 10_29/04/21 - N/W RELEASE
 11_28/01/24 - CC
 ADD IP RATING VIEW
 12_10/01/24 - CC
 Remove I-PEX MHF detail view.
 13_16/02/25 - CC
 Add GCT logo.

Scale: NTS	THIRD ANGLE	Unstated Tolerances:
Drawn: CC		X ±0.2 XX ±0.2 XXX ±0.2 ANGLES N/A
App'd: XXX	Title CABLE ASSEMBLY	
Date: 16 Feb. '25	Revision: 1.3	Unit: mm

IP Rated RF Products

www.gct.co www.gradconn.com

Drawing Number: CAB466RF

Sheet 1 of 1

Drawing © E and O E

THIS DRAWING IS CONFIDENTIAL AND MUST NOT BE COPIED OR DISCLOSED WITHOUT WRITTEN CONSENT