

RFPC-SMA17-FN: RP SMA Straight Bulkhead Jack With O-ring, PCB Connector, Rated to IP67/68, 3GHz

Material and Plating:

- Insulator A: Teflon
- Insulator B: Teflon
- Body: Brass, Gold Plated
- Pin: Brass, Gold Plated
- Gasket: Silicone, Color: Red
- O-Ring: Silicone, Color: Red

Washer: Brass, Gold Plated

Nut: Brass, Gold Plated

Environmental:

- A. Tested to:
  - i. IP6x - Dust tight - no particle ingress.
  - ii. IPx7 Waterproof for 30 minutes up to 1 meter underwater.
  - iii. IPx8 Waterproof for 48 hours at 1 meter underwater.

Notes:

1. Packaging Type: Tray.
2. Working Frequency Range: DC-3GHz.
3. Operating Temperature: -55°C~+155°C.
4. Impedance: 50 ohm.

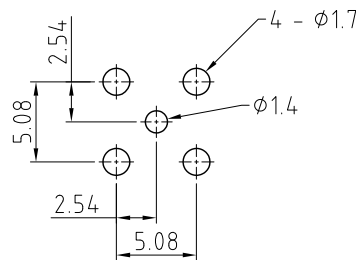
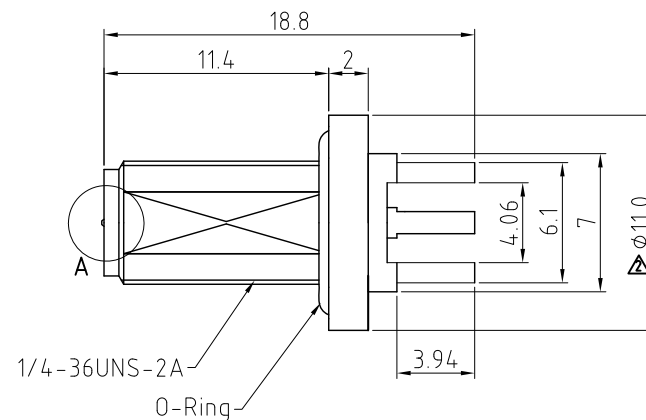
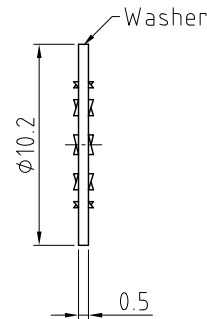
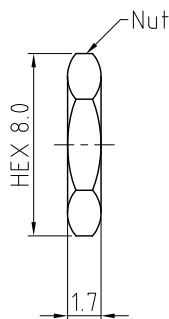

Recommended PCB Hole Layout

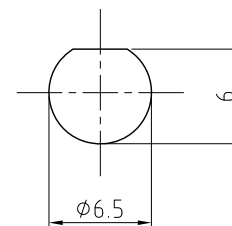

Recommended Mounting Hole

Applicable Panel Thickness:  
Min. 0.7mm ~ Max. 3.2mm

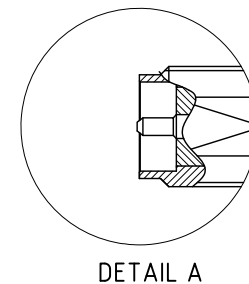

HOW TO ORDER  
RFPC - SMA17 - FN - X

WASHER AND NUT OPTIONS:  
BLANK = SEPARATELY PACKED (STANDARD)  
A = ALL ASSEMBLED WITH CONNECTOR

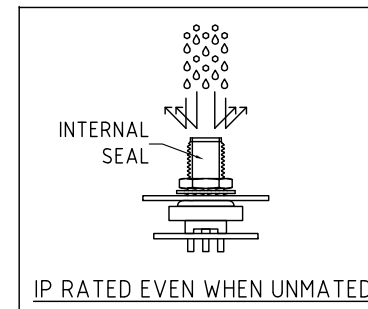

REV. DATE & DRN
10 30/07/18 - NYW RELEASE
11 30/08/18 - NYW
12 01/09/18 - NYW
12 27/12/18 - NYW
13 18/02/19 - NYW
13 18/02/19 - NYW
14 27/05/19 - NYW
15 16/02/23 - NYW
16 01/03/24 - CC
17 31/03/24 - CC
ADD IP RATING VIEW

Scale: NTS	THIRD ANGLE	Unstated Tolerances:
Drawn: CC		.X ±0.2
App'd: XXX	Title SMA PCB Connector	.XX ±0.2
Date: 31 MAR. '24	Revision: 1.7	.XXX ±0.2
	Unit: mm	ANGLES N/A

		Type: RFPC-SMA17-FN
IP Rated RF Products	www.gradconn.com	RFPC-SMA17-FN
© THIS DRAWING IS CONFIDENTIAL AND MUST NOT BE COPIED OR DISCLOSED WITHOUT WRITTEN CONSENT		Drawing Number:
		Sheet 1 of 1
		Drawing © E and O E