

CH03-BK - SIM CARD HOLDER WITH SWITCH 6 OR 8 PINS LOW PROFILE

FEATURES

1. GENERAL CHARACTERISTICS  
 DIMENSIONS: 29.65L x 17.20W x 2.00H mm  
 WEIGHT: APPROX. 0.75g  
 CONTACT PRINCIPLE: FRICTION TECHNOLOGY  
 OPERATING POSITION: SHAFT UP / DOWN / HORIZONTAL  
 MOUNTING SYSTEM: SMT TYPE (post optional)  
 DURABILITY: 10,000 CYCLES MIN.

2. MECHANICAL CHARACTERISTICS  
 INSULATION MATERIAL: THERMOPLASTIC, UL 94V-0

3. ELECTRICAL CHARACTERISTICS  
 NUMBER OF CONTACTS (OPTIONAL): 6, 8 PINS  
 CONTACT RESISTANCE: 50M OHMS TYP. 100M OHMS MAX.  
 INSULATION RESISTANCE: > 1000M OHMS / 500V DC  
 SWITCH TYPE: BLADE (Normally Open)

4. SOLDERABILITY  
 WAVE: NOT APPLICABLE  
 IR REFLOW: 260°C, 10 SEC. MAX.  
 MANUAL SOLDERING: 360°C, 3 SEC. MAX.

5. ENVIRONMENTAL CHARACTERISTICS  
 OPERATING TEMPERATURE: -40°C ~ +85°C  
 OPERATING HUMIDITY: 10% ~ 95% RH  
 STORAGE TEMPERATURE: -40°C ~ +85°C  
 STORAGE HUMIDITY: 10% ~ 95% RH

NOTES:  
 1. ACCEPTABLE SIM CARD SIZE SHOULD MEET GSM 11.11 SPECIFICATION REQUIREMENT.

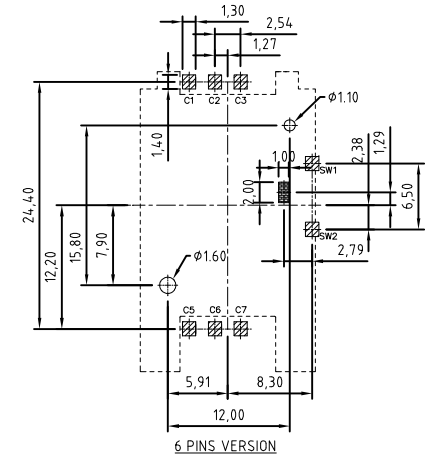
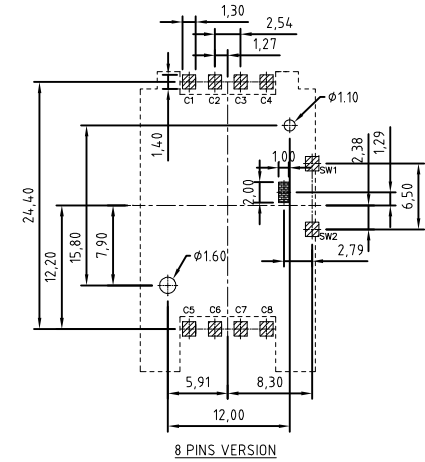
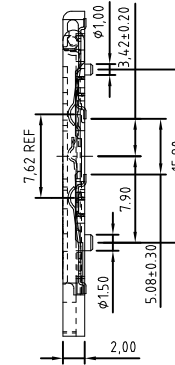
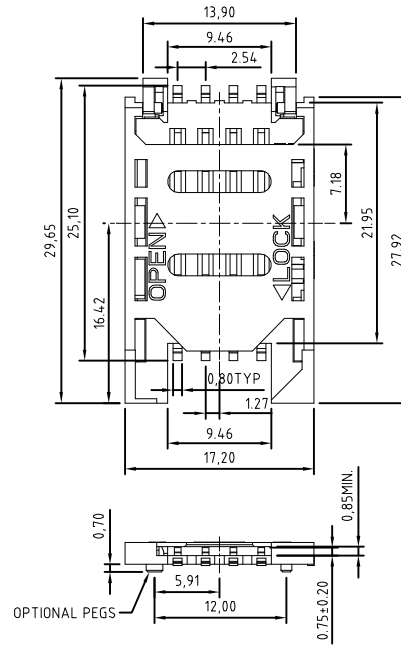
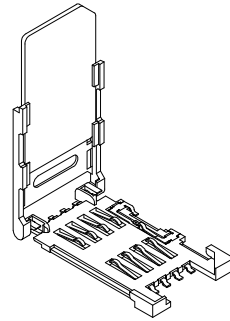

Hatched area is pattern prohibition area  
 Tolerance: ±0.05  
 RECOMMENDED PCB LAYOUT

HOW TO ORDER



NO. OF CONTACTS  
 06 OR 08

WITH OR WITHOUT  
 LOCATING PEG  
 A = WITH  
 B = WITHOUT

PACKAGING OPTIONS  
 R = REEL  
 (600PCS/REEL)

REV. DATE & DRN  
 T0 15/07/08 - NYW RELEASE  
 T1 28/04/09 - PN  
 PACKAGING DRAWING ADDED

Scale: 2:1	THIRD ANGLE	Unstated Tolerances: XX ±0.15	Material SEE NOTE
Drawn: NYW			
App'd: XXXX	Title SIM CARD ACCEPTOR		NOT TO SCALE
Date: 28 APR '09	Revision: 1.1		Unit: mm



www.gradconn.com

THIS DRAWING IS CONFIDENTIAL AND MUST NOT BE COPIED OR DISCLOSED WITHOUT WRITTEN CONSENT

Type: CH03-BK

CH03-BK

Drawing Number:

Sheet 1 of 2

Drawing Code E and 0 E

CH03-BK - SIM CARD HOLDER WITH SWITCH 6 OR 8 PINS LOW PROFILE - PACKAGING DRAWING

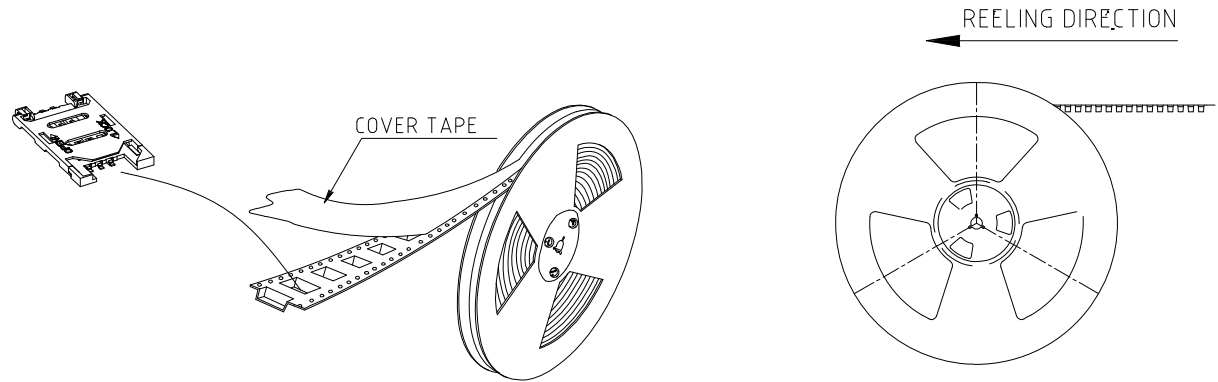
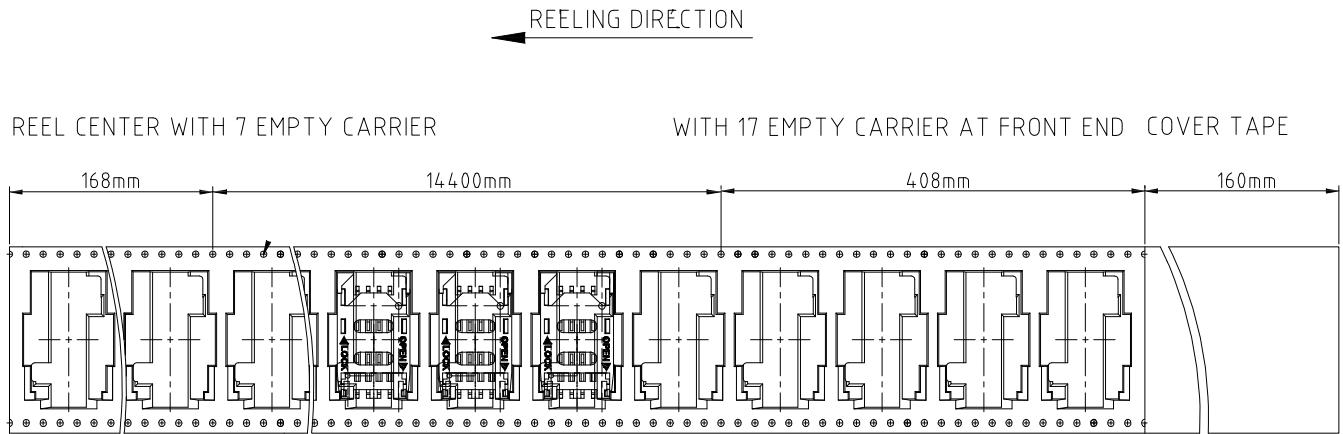
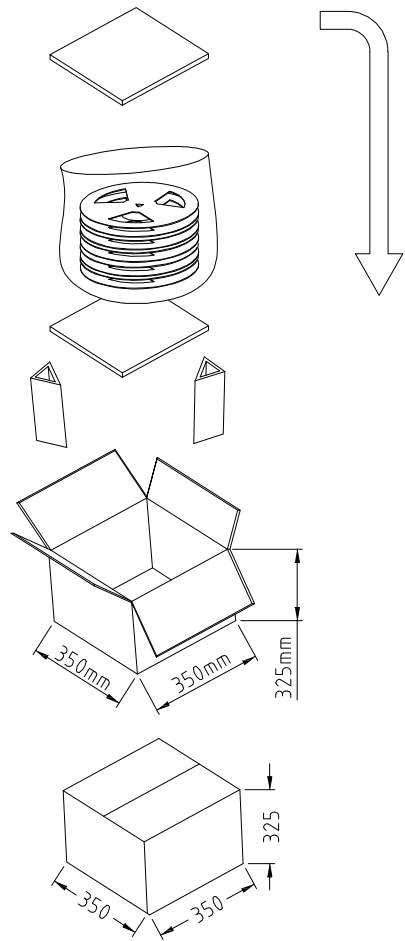

- NOTES:
1. REEL DIA.: 33CM.
  2. 600PCS PER REEL, GROSS WEIGHT: 1.00KG.
  3. 6 REELS PER FULL CARTON, GROSS WEIGHT: 7.20KG.

REV. DATE & DRN 10/28/04/09 - AE PACKAGING DRAWING ADDED	Scale: 2:1	THIRD ANGLE	Unstated Tolerances:	Material SEE NOTE	 www.gradconn.com THIS DRAWING IS CONFIDENTIAL AND MUST NOT BE COPIED OR DISCLOSED WITHOUT WRITTEN CONSENT	Type: CH03-BK
	Drawn: AE					CH03-BK
	App'd: XXXX	Title: SIM CARD ACCEPTOR		NOT TO SCALE		Drawing Number:
	Date: 28 APR '09	Revision: 1.0		Unit: mm		Sheet 2 of 2

Drawing C <input type="radio"/> E and O E
---