



GRADConn

Product Overview

Edition
#19

Contents

- 2 About GradConn
- 3 Product Overview
- 4 GradConn.com Online Tools
- 5 Board-to-Board Connectors
- 7 Nautilus IP-Rated Coaxial Connectors
- 8 Coaxial Cable Assemblies
- 9 Micro Coaxial Cable Assemblies
- 10 MMCX
- 11 SIM Card Connectors
- 13 Wire-to-Board Connectors
- 14 Distribution

About GradConn

Making exceptional connectors and coaxial cable assemblies for the electronics industry.

Whether it's board-to-board, SIM connectors, coaxial cable assemblies or wire-to-board solutions, **GradConn** has the right connections for your designs.

GradConn, Ltd. combines industry leading electronic connectors and coaxial cable assemblies with a full and comprehensive end-to-end service, from design all the way to volume production, globally.

Recognised worldwide for its comprehensive range of board-to-board connectors and high performance IP rated coaxial solutions, **GradConn** has offices in Taiwan, UK and the US supported by a global sales and distribution network across 160 countries. Working with **GradConn** and obtaining its connectors couldn't be easier.

GradConn's expert team is on hand to offer design advice, product samples, design resources and assistance with pre-production requirements. This is all part of the **GradConn's** extensive service to help speed up your design and get your product to the market quickly.



Product Overview

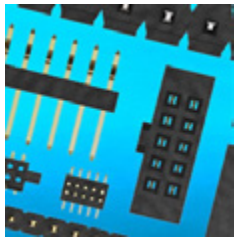

Board-to-Board Connectors

Full range of Board-to-Board connectors in 0.8mm x 1.2mm, 1.0mm, 1.27mm, 2mm, 1.27mm x 2.54mm, 2.54mm, 3.96mm and 5.08mm pitches and Wire to board solutions, including PCB headers and cable assemblies in 0.8mm and 1.00mm pitch.



Nautilus

Nautilus is a range of waterproof coaxial cable assemblies and connectors which offer IP67 & IP68 protection from moisture and particle ingress mated and unmated. Front and rear bulkhead mounts in standard and reverse polarity, in 3GHz and an ever increasing range of 6GHz products.

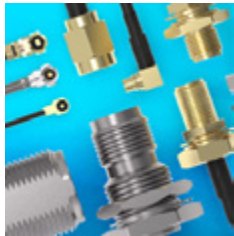

Coaxial Cable Assemblies & Connectors

A wide variety of Coaxial Cable Assemblies and Connectors, with particular strength in micro coaxial cables for wireless applications. These often use a micro coax cable assembly mating with a wireless module on the PCB to connect to an external antenna.

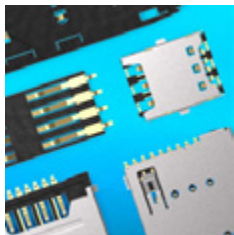

SIM Card Connectors

GradConn's range of SIM card connectors are designed to provide a secure and stable functionality for wireless applications. Mini, Micro and Nano sizes are available in a selection of different card insertion styles, including push-pull, hinged and more.

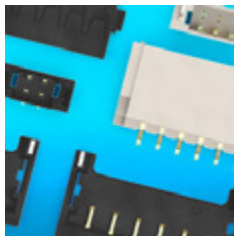

Wire-to-Board Connectors

Wire-to-Board connectivity solutions including cable assemblies and PCB headers. Connectors are available in 0.8mm, 1.00mm and 1.20mm pitches with tiny PCB footprints and low profile mated heights to suit your design.

GradConn.com Tools

BoardtoBoard Stacking Calculator

The board to board stacking calculator is a step by step system to find the perfect vertical mating connector design solution.

www.gradconn.com/Products/BoardToBoard/PCBStacking



Coaxial Cable Assembly Builder

A range of filters help build your ideal assembly from our huge range, allowing you to define cable length, working frequency, connector type & orientation.

www.gradconn.com/Products/CoaxialCableAssembly/CableBuilder

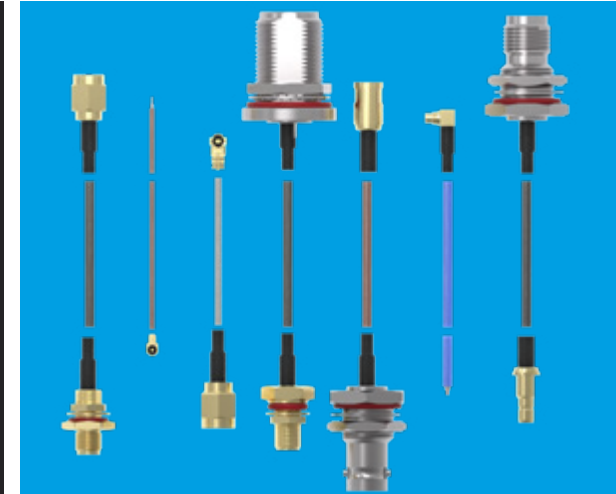

Coplanarity Mating Guide

A range of perfectly height-matched PCB connectors for end-to-end planar mating.

www.gradconn.com/Products/BoardToBoard/CoPlanarConnectors

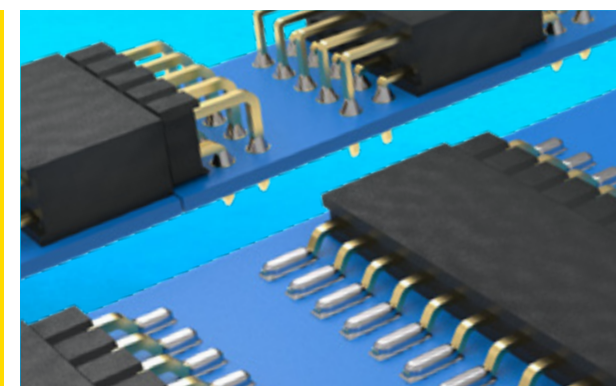

Board-to-Board

FINE PITCH

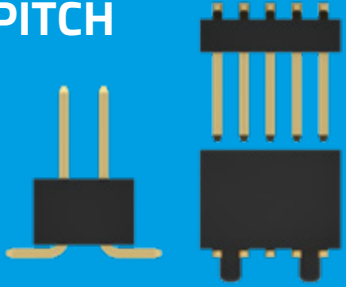

0.80 x 1.20mm,
1.0mm & 1.27mm

GradConn offer a wide range of board-to-board connectors in a variety of pin spacing pitches from 0.8mm thru 2.00mm, 2.54mm and up to 5.08mm.

HIGH CURRENT



APPLICATION VERSIONS

CUSTOM DESIGNS

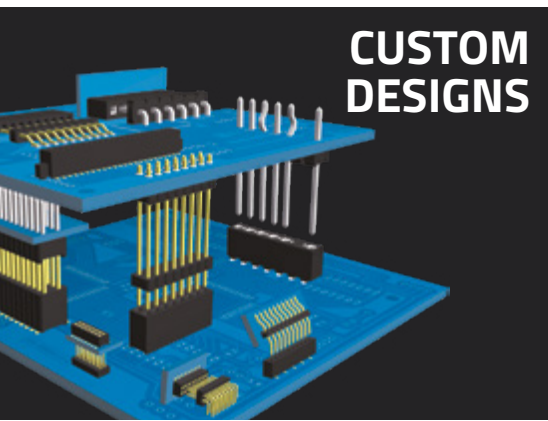

ELEVATED VERSIONS

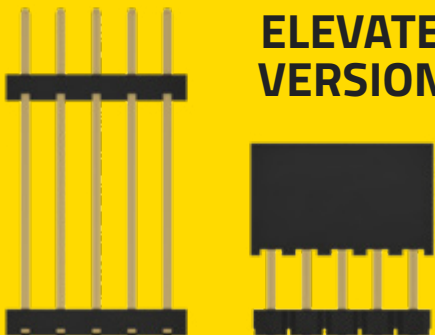

2.54mm PIN PITCHES

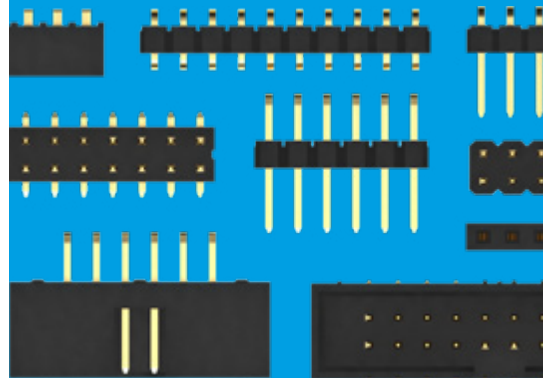

IN A VARIETY OF CONFIGURATIONS

SIM Card Connectors

COST-EFFECTIVE MICRO

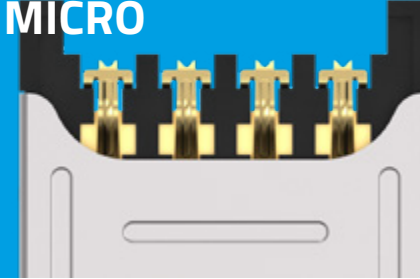

GradConn SIM connectors are available in Mini, Micro & Nano, accepting all card sizes, with provision for cards with 6 or 8 contacts.

SECURE HINGED VARIANTS

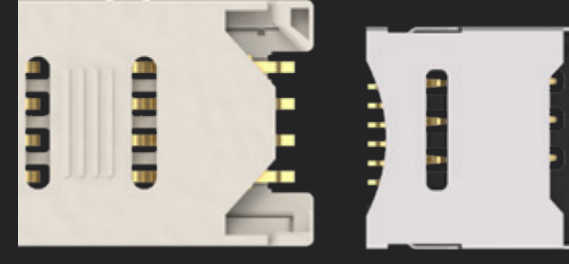

TINY PCB FOOTPRINT NANO

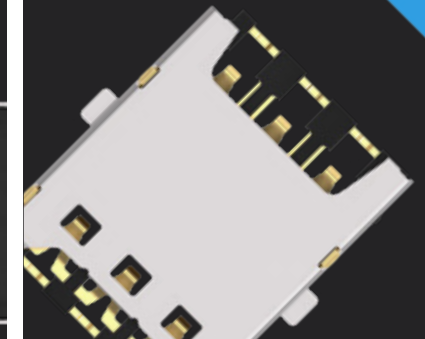

PUSH-PUSH CARD EJECT

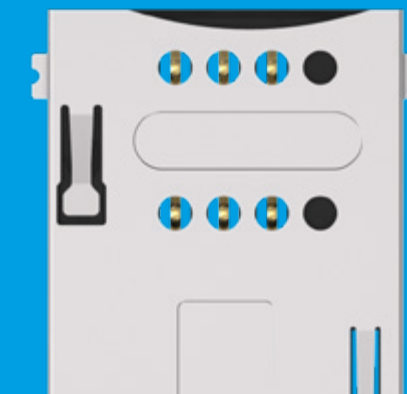

DUAL MINI SIM STACK SOLUTION

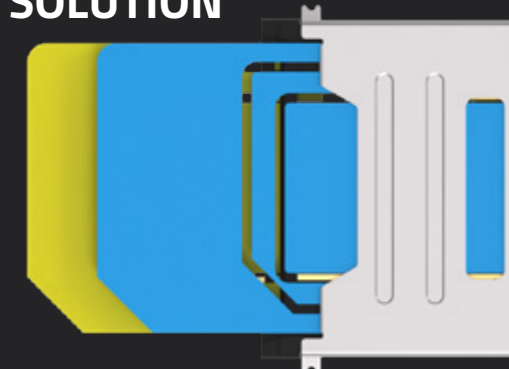

Nautilus - Waterproof

Coaxial Cable Assemblies



Nautilus is a range of premium DC-to-6GHz **IP67/68** rated dust and **waterproof coaxial connectors and cable assemblies.**

Dust tight – no particle ingress **IP6x**

Waterproof for 30 mins (1m depth) **IPx7**

Waterproof for 12 hours (1m depth)
24 hours (5m depth) **IPx8**

Why Choose Nautilus?

- **Premium quality**, competitively priced connectors & cable assemblies.
- **PCB mount** options in right-angle and vertical orientations.
- Modular range allows **maximum flexibility** for customers when selecting the correct solution for their application.
- **Short lead times**, even on custom-built assemblies.
- 3D models to assist with virtual designs.
- Fully tested to both **IP67 & IP68** with test reports available.
- Range of **metal caps** with or without chain attachments.
- **Extended Environmental Testing** on Nautilus SMA connectors.



5 Year Simulation



Prolonged exposure to water



Salt spray resistance



Rapid thermal shock

POPULAR SMA VARIANTS

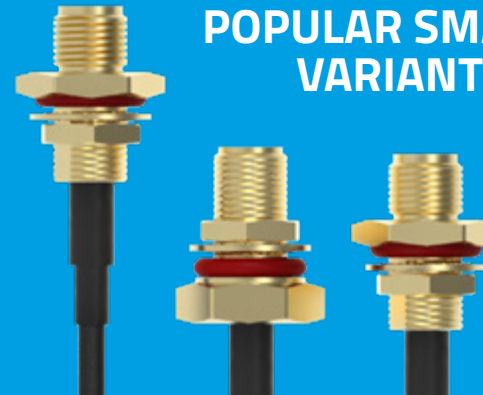

STANDARD & REVERSE POLARITIES

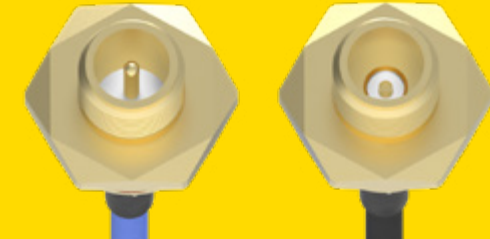

FRONT

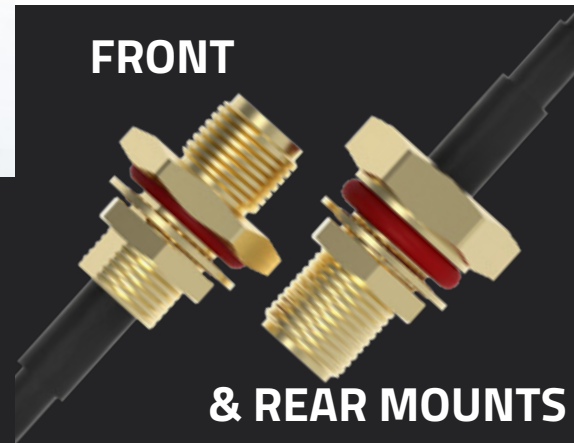

& REAR MOUNTS

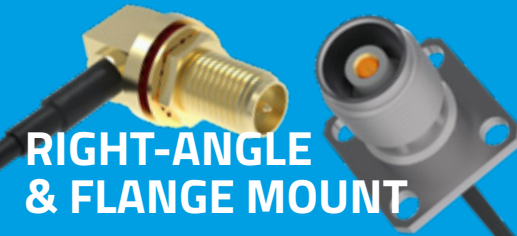

RIGHT-ANGLE & FLANGE MOUNT

PCB MOUNT VERSIONS

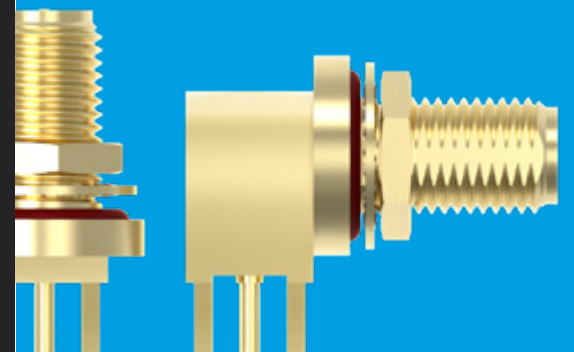

TNC, BNC & N TYPE

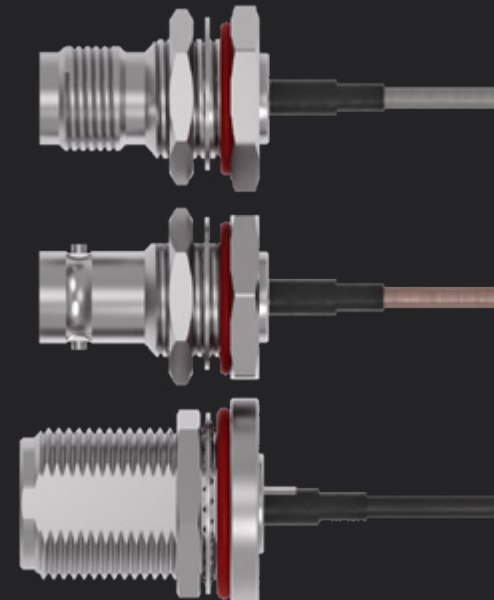

Coaxial Assemblies

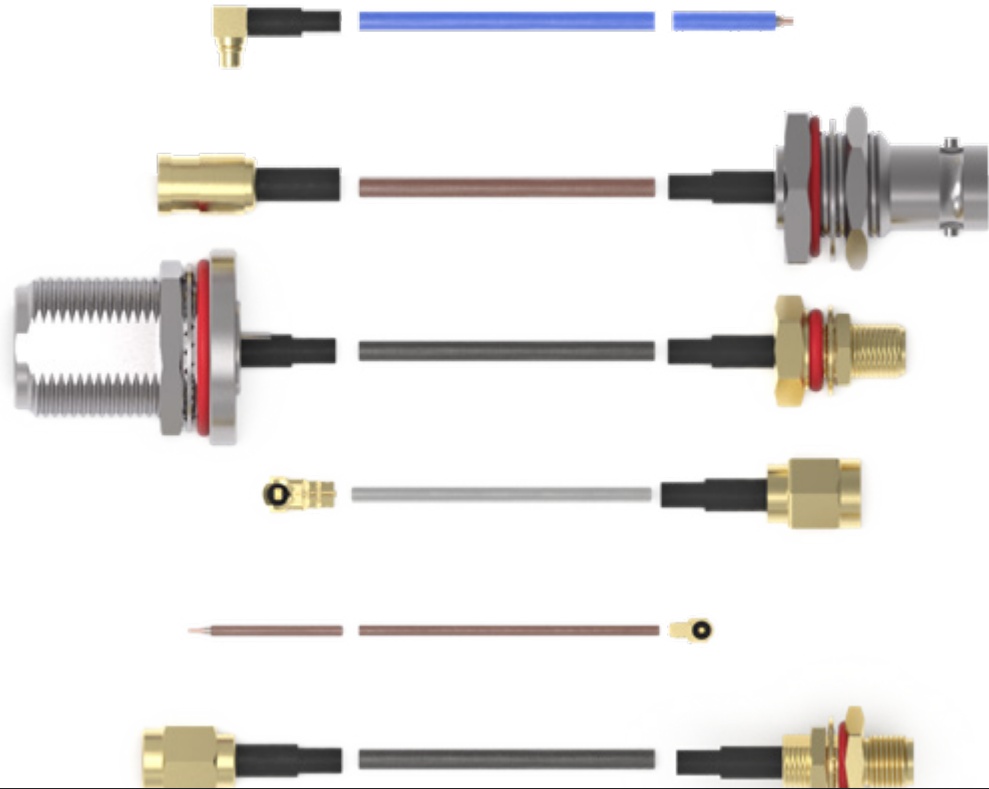

Micro Coaxial



Microcoax cable assemblies mate with a wireless module on the PCB, a length of cable is often used to break out of the product via an interface connector with a cutout in the bulkhead.

GradConn offer a wide variety of micro coaxial cable assemblies for wireless markets, such as GSM, GPS, Wireless LAN (WLAN), Wi-Fi, Zigbee Z-Wave, EnOcean and Bluetooth.

- Extensive range of cable assemblies & technical drawings online.
- Online cable assembly builder for customised designs.
- Huge range of micro and interface connector options.
- Original Hirose and Murata micro connectors.
- Economical micro connector options from I-PEX.
- Multiple cable specifications, including stripped & tinned ends
- IP67/68 Nautilus assemblies (see page 7).
- Test Probe Assemblies

MMCX connectors are one of our most popular micro formats, featuring a snap-on mechanism that allows for completely free 360° rotation when plug and jack are mated. They are available in right-angle and straight plug configurations and have a working frequency range of DC to 6GHz.

Right-Angle Jack
Surface Mount PCB Mount

Straight Jack
Through-Hole PCB Mount

Right-Angle Jack
Surface Mount PCB Mount

Straight Jack
Through-Hole PCB Mount



Wire-to-Board



GradConn offer Wire-to-Board connectivity solutions, offering both cable assemblies and PCB headers. Connectors are available in 0.8mm, 1.00mm and 1.20mm pitches with tiny PCB footprints and low profile mated heights.

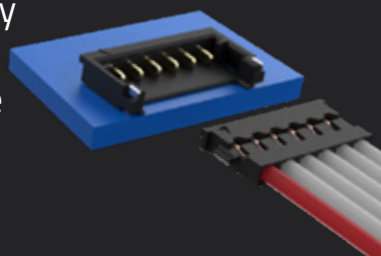

GradConn to GradConn

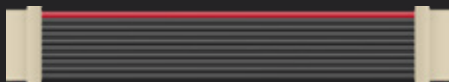

GradConn to Competitor (eg. Molex)



GradConn to GradConn Breakout

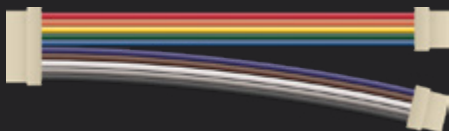

GradConn to Standard (eg. D-Sub)

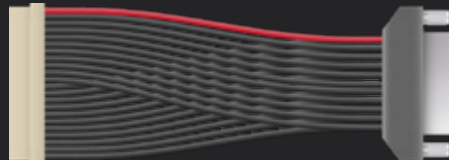

Product Applications

DRONE CAMERAS



SMART METERING

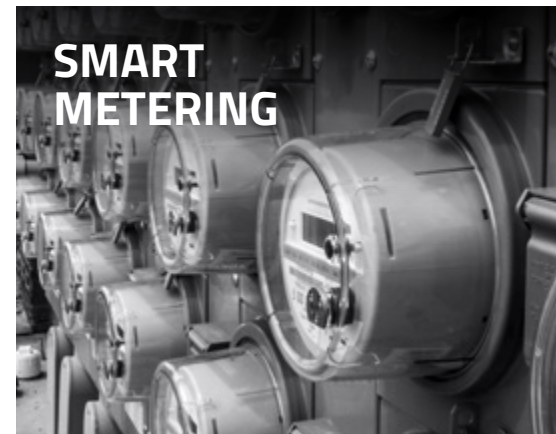

SECURITY EQUIPMENT



AGRI-TECH



ASSET TRACKING & FLEET MANAGEMENT



WIRELESS COMMUNICATIONS



Distribution



GradConn is supported by a worldwide network of international, national and local distributors and representatives.



For the complete list of our distributors, including those local to your region, please visit the web link below.

www.gradconn.com/DistributorsReps

Find your perfect solution, fast.



Expert information & advice

Product drawings & 3D models

Available in English and German

Useful online design tools

Latest product specifications and updates

Optimised for mobile & tablet devices

www.gradconn.com

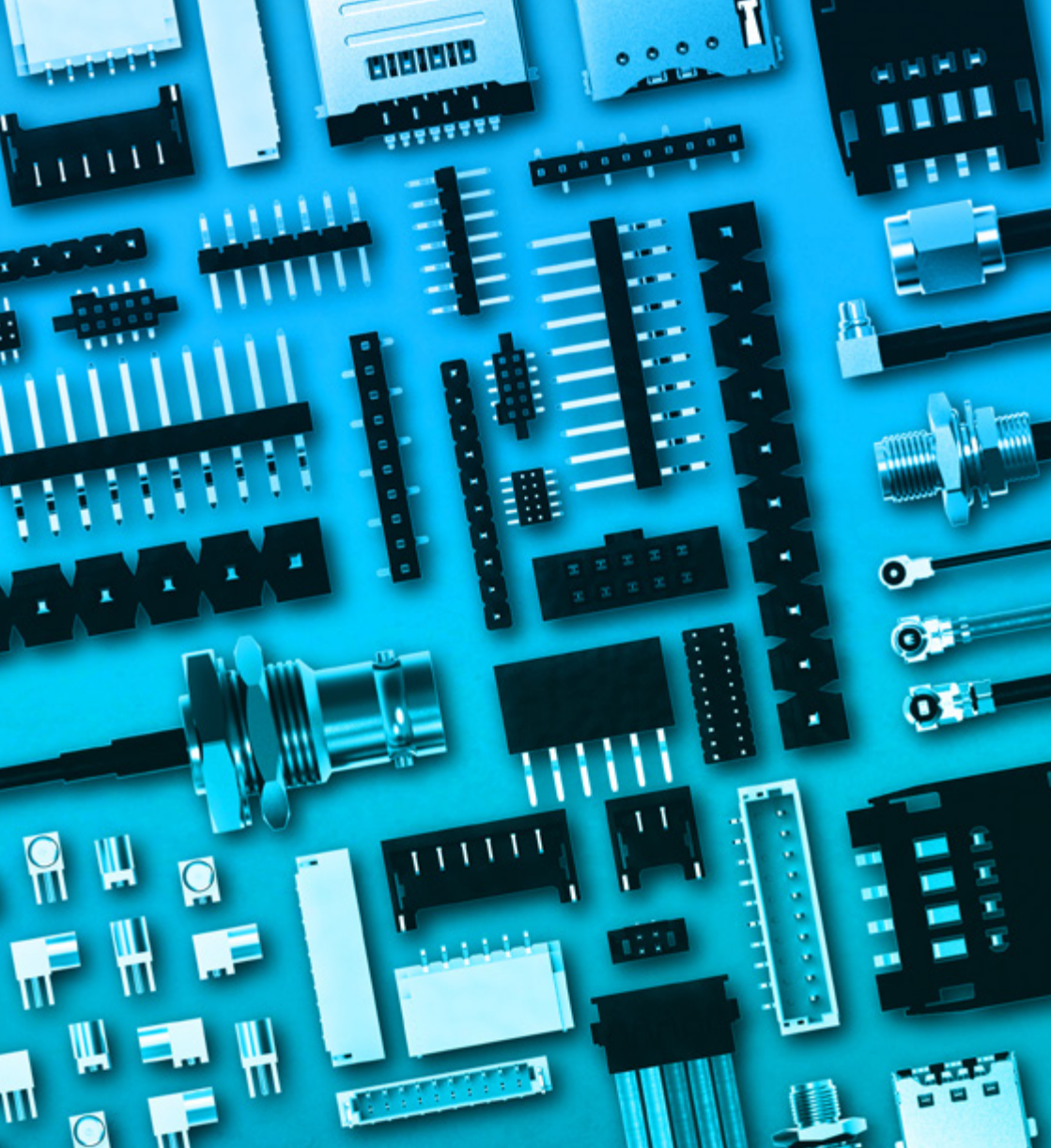

GradConn Europe

International House
61 Mosley Street
Manchester
M2 3HZ
UK

+44 (0) 208 236 0005
SalesEurope@GradConn.com

GradConn Taiwan (HQ)

209 Minsheng Road
Longtan District
Taoyuan City
32554
Taiwan

Tel: +886 3 499 3132
Sales@GradConn.com

GradConn USA

1825 NW Corporate Blvd
Suite 110
Boca Raton
FL 33431
USA

+1 (954) 903 3394
SalesUSA@GradConn.com

www.gradconn.com